



Parameter	Rating	Units
Blocking Voltage	350	V _p
Load Current	120	mA
Max On-resistance	35	Ω

Features

- 100% Solid State
- Small 6-Pin Package
- Low Drive Power Requirements (TTL/CMOS Compatible)
- High Reliability
- Arc-Free With No Snubbing Circuits
- 3750V_{rms} Input/Output Isolation
- No EMI/RFI Generation
- Machine Insertable, Wave Solderable
- Surface Mount Tape & Reel Version Available
- Flammability classification rating of V-0

Applications

- Instrumentation
 - Multiplexers
 - Data Acquisition
 - Electronic Switching
 - I/O Subsystems
 - Meters (Watt-Hour, Water, Gas)
- Medical Equipment—Patient/Equipment Isolation
- Security
- Aerospace
- Industrial Controls

Description

The LCA110 is a 1-Form-A Solid State Relay which uses optically coupled MOSFET technology to provide 3750V_{rms} of input to output isolation. The efficient MOSFET switches and photovoltaic die use Clare's patented OptoMOS® architecture. The optically coupled output is controlled by a highly efficient GaAIAs infrared LED. The LCA110 can be used to replace mechanical relays and offers the superior reliability associated with semiconductor devices. Because they have no moving parts, they can offer faster, bounce-free switching in a more compact surface mount or through hole package.

Approvals

- UL Recognized: File Number E76270
- CSA Certified: File Number LR 43639-10
- EN/IEC 60950-1:2001 Compliant

Ordering Information

Part Number	Description
LCA110	6-Pin DIP (50/Tube)
LCA110S	6-Pin Surface Mount (50/Tube)
LCA110STR	6-Pin Surface Mount (1,000/Reel)

Pin Configuration

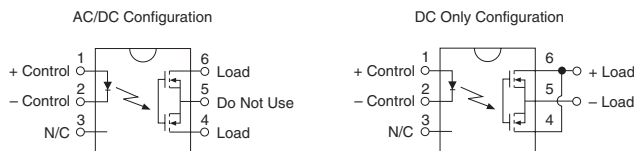

Switching Characteristics of Normally Open (Form A) Devices

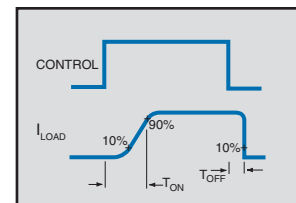

Absolute Maximum Ratings

Parameter	Ratings	Units
Blocking Voltage	350	V_p
Reverse Input Voltage	5	V
Input Control Current	50	mA
Peak (10ms)	1	A
Input Power Dissipation ¹	150	mW
Total Power Dissipation ²	800	mW
Isolation Voltage, Input to Output	3750	V_{rms}
Operational Temperature	-40 to +85	°C
Storage Temperature	-40 to +125	°C

¹ Derate Linearly 1.33 mW/°C

² Derate Linearly 6.67 mW/°C

Electrical absolute maximum ratings are at 25°C

Absolute Maximum Ratings are stress ratings. Stresses in excess of these ratings can cause permanent damage to the device. Functional operation of the device at conditions beyond those indicated in the operational sections of this data sheet is not implied.

Electrical Characteristics

Parameter	Conditions	Symbol	Min	Typ	Max	Units
Output Characteristics @ 25°C						
Load Current (Continuous)						
AC/DC Configuration	-	I_L	-	-	120	mA
DC Configuration			-	-	200	
Peak Load Current	t=10ms	I_{LPK}	-	-	350	mA
On-resistance						
AC/DC Configuration	$I_L=120mA$	R_{ON}	-	23	35	Ω
DC Configuration	$I_L=200mA$		-	7	10	
Off-State Leakage Current	$V_L=350V$	I_{LEAK}	-	-	1	μA
Switching Speeds						
Turn-On	$I_F=5mA, V_L=10V$	T_{ON}	-	-	3	ms
Turn-Off		T_{OFF}				
Output Capacitance	50V; f=1MHz	C_{OUT}	-	25	-	pF
Input Characteristics @ 25°C						
Input Control Current	$I_L=120mA$	I_F	-	-	2	mA
Input Dropout Current	-	I_F	0.4	-	-	mA
Input Voltage Drop	$I_F=5mA$	V_F	0.9	1.2	1.4	V
Reverse Input Current	$V_R=5V$	I_R	-	-	10	μA
Common Characteristics @ 25°C						
Input to Output Capacitance	-	$C_{I/O}$	-	3	-	pF

PERFORMANCE DATA*

LCA110
Typical LED Forward Voltage Drop
($T_A = 25^\circ\text{C}$; $I_F = 5\text{mA}_{\text{DC}}$)
N=50

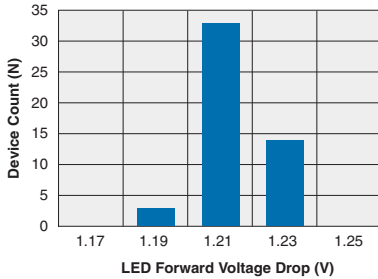

LCA110
Typical On-resistance Distribution
($T_A = 25^\circ\text{C}$; $I_L = 120\text{mA}_{\text{DC}}$)
N=50

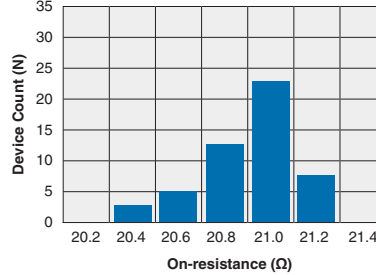

LCA110
Typical Blocking Voltage Distribution
($T_A = 25^\circ\text{C}$)
N=50

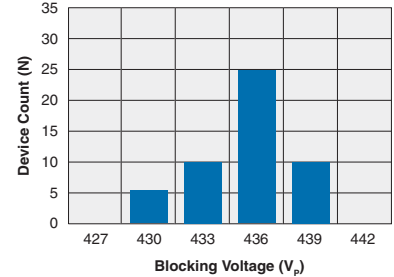

LCA110
Typical I_F for Switch Operation
($T_A = 25^\circ\text{C}$; $I_L = 120\text{mA}_{\text{DC}}$)
N=50

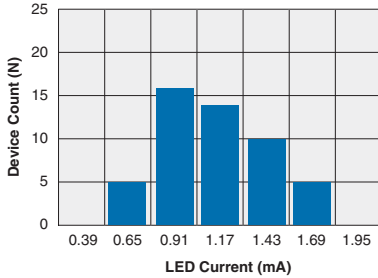

LCA110
Typical I_F for Switch Dropout
($T_A = 25^\circ\text{C}$; $I_L = 120\text{mA}_{\text{DC}}$)
N=50

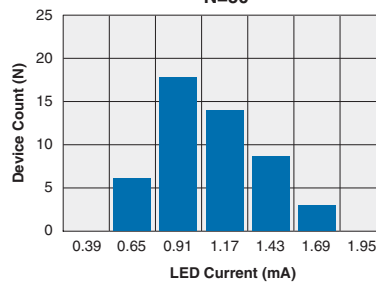

LCA110
Typical Turn-On Time
($T_A = 25^\circ\text{C}$; $I_L = 120\text{mA}_{\text{DC}}$; $I_F = 2\text{mA}_{\text{DC}}$)
N=50

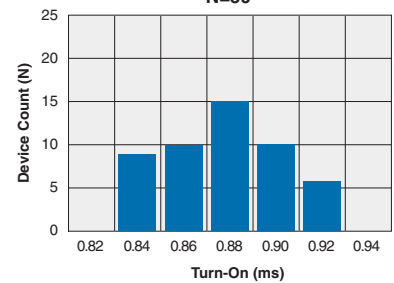

LCA110
Typical Turn-Off Time
($T_A = 25^\circ\text{C}$; $I_L = 120\text{mA}_{\text{DC}}$; $I_F = 2\text{mA}_{\text{DC}}$)
N=50

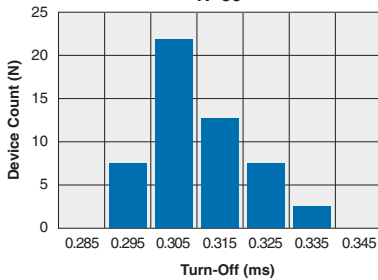

LCA110
Typical Load Current vs. Temperature

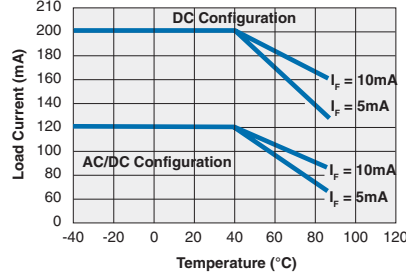

LCA110
Typical Leakage vs. Temperature
(Measured across Pins 4 & 6)

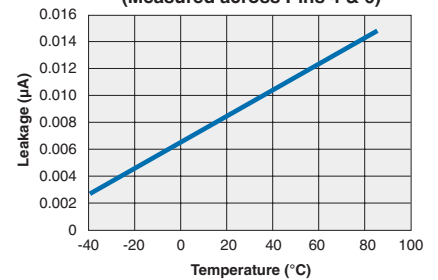

LCA110
Typical Blocking Voltage vs. Temperature

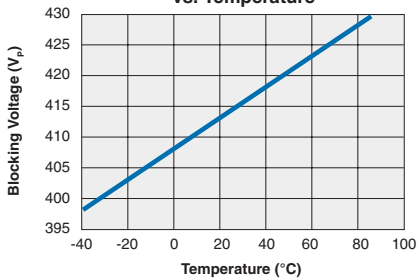

LCA110
Typical Turn-On vs. Temperature
($I_L = 70\text{mA}_{\text{DC}}$)

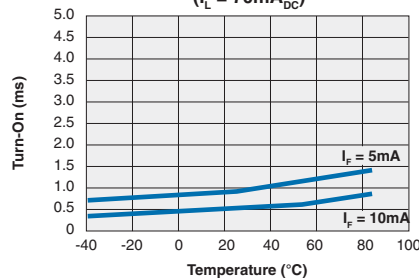

LCA110
Typical Turn-Off vs. Temperature
($I_L = 70\text{mA}_{\text{DC}}$; $I_F = 5\text{mA}$)

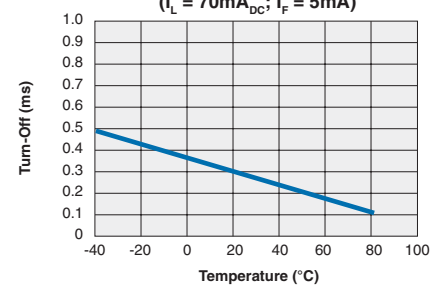

*The Performance data shown in the graphs above is typical of device performance. For guaranteed parameters not indicated in the written specifications, please contact our application department.

PERFORMANCE DATA*

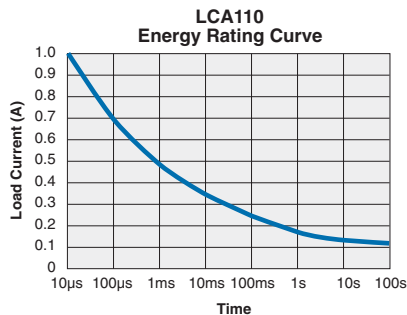
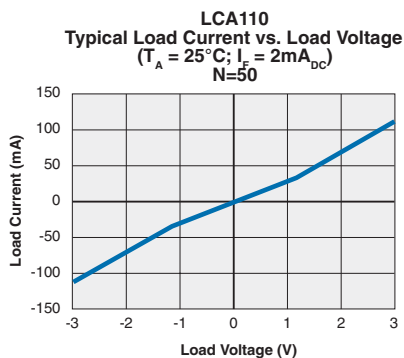
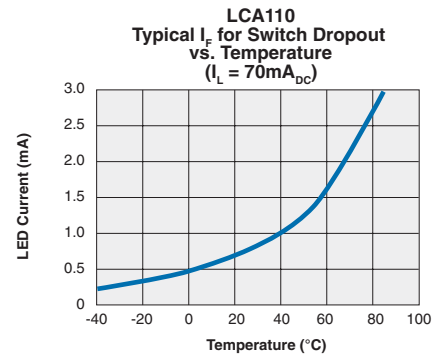
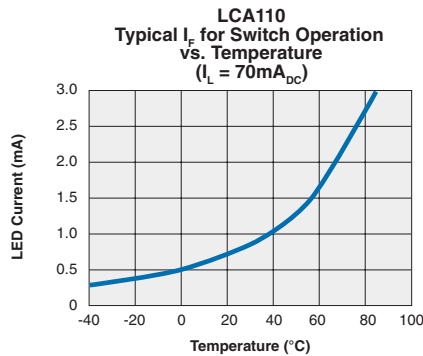
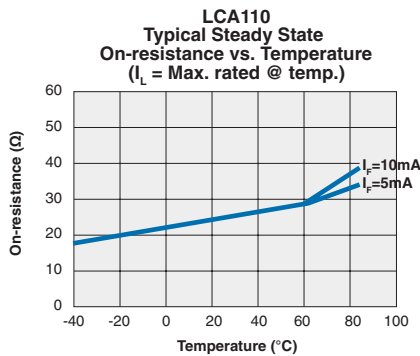
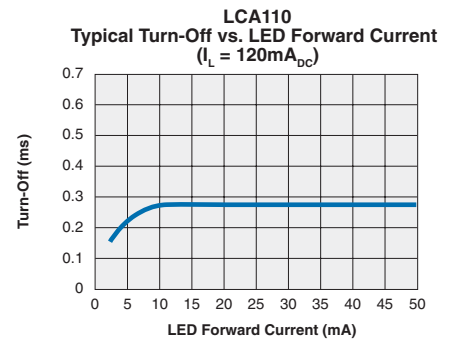
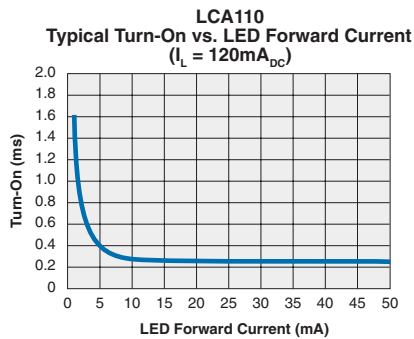
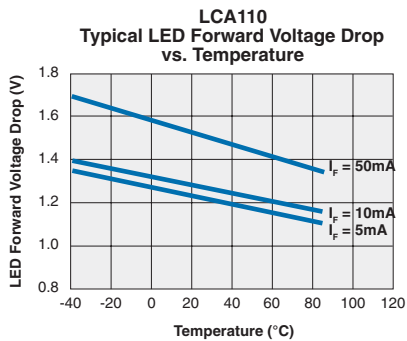

*The Performance data shown in the graphs above is typical of device performance. For guaranteed parameters not indicated in the written specifications, please contact our application department.

Manufacturing Information

Soldering

For proper assembly, the component must be processed in accordance with the current revision of IPC/JEDEC standard J-STD-020. Failure to follow the recommended guidelines may cause permanent damage to the device resulting in impaired performance and/or a reduced lifetime expectancy.

Recommended soldering processes are limited to 260°C component body temperature for 10 seconds.

Washing

Clare does not recommend ultrasonic cleaning or the use of chlorinated solvents.



MECHANICAL DIMENSIONS

6-Pin DIP Through Hole (Standard)

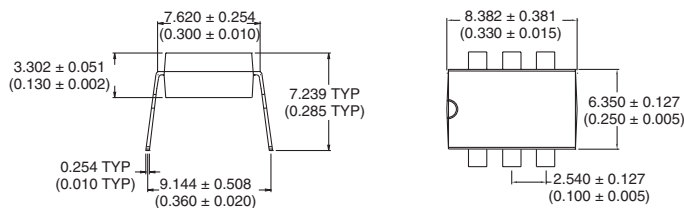

PC Board Pattern (Top View)

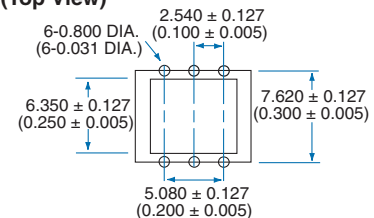

6-Pin Surface Mount ("S" Suffix)

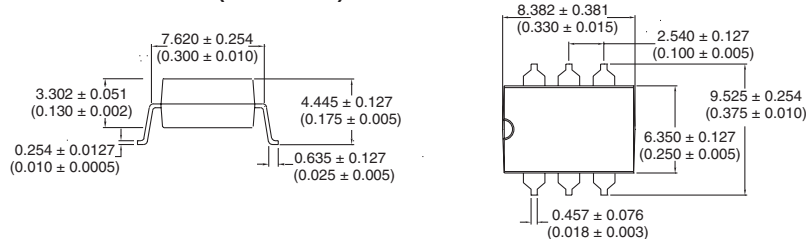

PC Board Pattern (Top View)

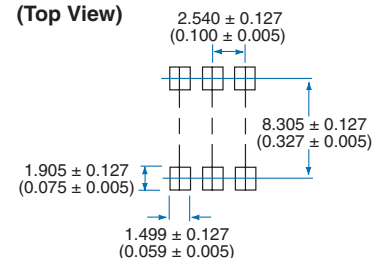

Tape and Reel Packaging for Surface Mount Package

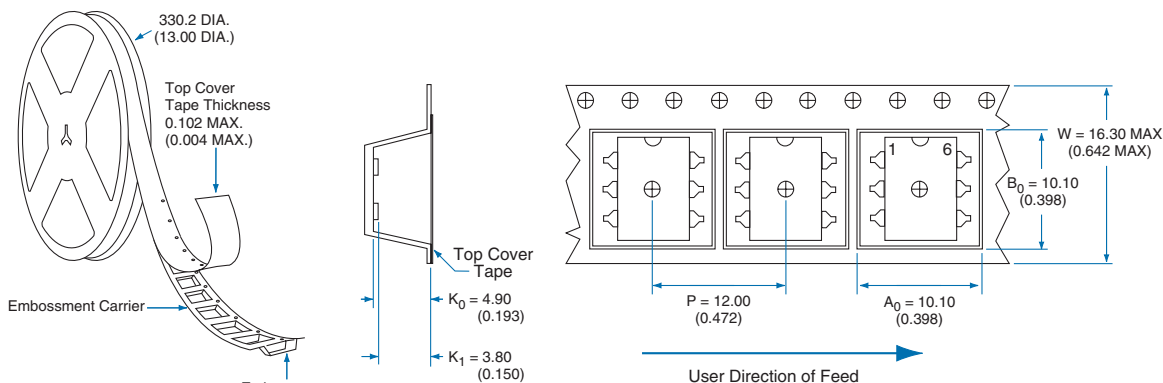

Dimensions:
mm
(inches)

For additional information please visit our website at: www.clare.com

Clare, Inc. makes no representations or warranties with respect to the accuracy or completeness of the contents of this publication and reserves the right to make changes to specifications and product descriptions at any time without notice. Neither circuit patent licenses nor indemnity are expressed or implied. Except as set forth in Clare's Standard Terms and Conditions of Sale, Clare, Inc. assumes no liability whatsoever, and disclaims any express or implied warranty, relating to its products including, but not limited to, the implied warranty of merchantability, fitness for a particular purpose, or infringement of any intellectual property right.

The products described in this document are not designed, intended, authorized or warranted for use as components in systems intended for surgical implant into the body, or in other applications intended to support or sustain life, or where malfunction of Clare's product may result in direct physical harm, injury, or death to a person or severe property or environmental damage. Clare, Inc. reserves the right to discontinue or make changes to its products at any time without notice.